

KAMATEK





RAIMAX AUSDREHKOPF



RAIMAX BORING HEAD



РАСТОЧНЫЕ ГОЛОВКИ РЕГУЛИРУЕМЫЕ RAIMAX



RAIMAX T TE



TESTINE RAIMAX



RAIMAX 镗头



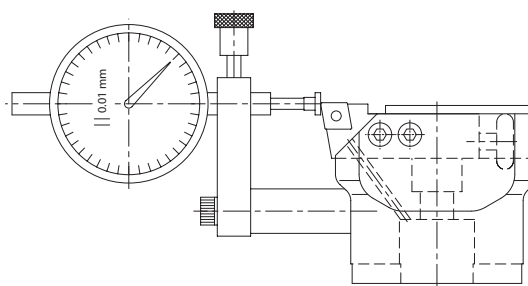
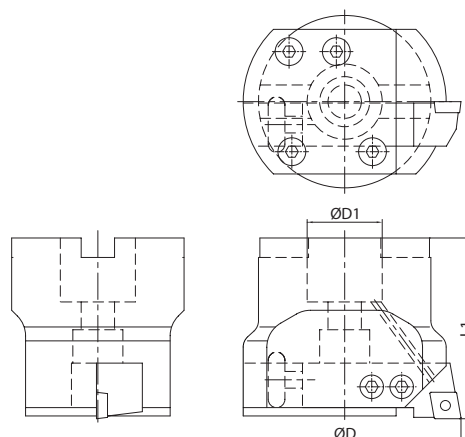

EINSTELLBARER AUSDREHKOPF
ADJUSTABLE BORING HEAD
РАСТОЧНЫЕ ГОЛОВКИ РЕГУЛИРУЕМЫЕ

TÊTE À ALÉSER RÉGLABLE
TESTINA REGOLABILE PER ALESATURA
可调镗头



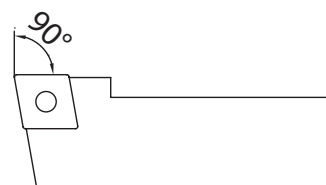

Code N.	d	d1	l1	Einbauhalter - Cartridges - Cartouches - Cartucce		
RAIMAX 30	Ø28-40	16	45	K-SCGCL 08-06	K-STGPL 08-09	-
RAIMAX 40	Ø39-55	16	50	K-SCGCL 10-06	K-STGPL 10-09	-
RAIMAX 50	Ø49-75	22	56	K-SCGCL 12-09	K-STGPL 12-11	K-SSXCL 12-09
RAIMAX 75	Ø74-115	27	65	K-SCGCL 16-09	K-STGPL 16-11	K-SSXCL 16-09
RAIMAX 100	Ø98-160	40	67	K-SCGCL 20-09	K-STGPL 20-11	K-SSXCL 20-09
RAIMAX 150	Ø148-250	40	67	K-SCGCL 20L-09	K-STGPL 20L-11	K-SSXCL 20L-09

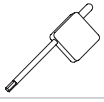

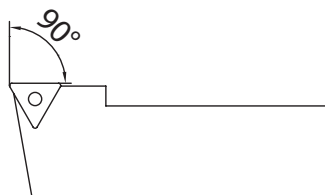

Code N.	Inserts N.	Screw	Wrench
			
K-SCGCL 08-06	CCMT 0602	KV28	Torx 7
K-SCGCL 10-06	CCMT 0602	KV28	Torx 7
K-SCGCL 12-09	CCMT 09T3	KV4c	Torx 15
K-SCGCL 16-09	CCMT 09T3	KV4c	Torx 15
K-SCGCL 20-09	CCMT 09T3	KV4c	Torx 15
K-SCGCL 20L-09	CCMT 09T3	KV4c	Torx 15



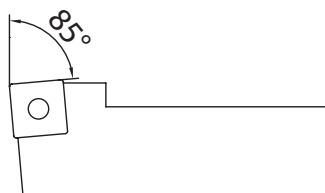

EINBAUHALTER
CARTRIDGES
КАРТРИДЖИ
CARTOUCHES
CARTUCCE
刀头



Code N.	Inserts N.	Screw	Wrench
			
K-STGPL 08-09	TPGX 0902	KV28	Torx 7
K-STGPL 10-09	TPGX 0902	KV28	Torx 7
K-STGPL 12-11	TPGX 1103	KV10	Torx 9
K-STGPL 16-11	TPGX 1103	KV10	Torx 9
K-STGPL 20-11	TPGX 1103	KV10	Torx 9
K-STGPL 20L-11	TPGX 1103	KV10	Torx 9

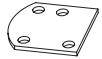

Code N.	Inserts N.	Screw	Wrench
			
K-SSXCL 12-09	SCMT 09T3	KV4c	Torx 15
K-SSXCL 16-09	SCMT 09T3	KV4c	Torx 15
K-SSXCL 20-09	SCMT 09T3	KV4c	Torx 15
K-SSXCL 20L-09	SCMT 09T3	KV4c	Torx 15

Code N.	Screw	Cover	Screw for cover	Screw	Screw
					
RAIMAX 30	KSR M8 R/L	KCC30	2 x KVCC30	KVR30	2 x KGG30
RAIMAX 40	KSR M8x20	KCC40	3 x KVCC40	KVR40	2 x KGG40
RAIMAX 50	KSR M10x20	KCC50	3 x KVCC50	KVR50	2 x KGG50
RAIMAX 75	KSR M12x25	KCC75	4 x KVCC75	KVR75	2 x KGG75
RAIMAX 100	KSR M20X	KCC100	4 x KVCC100	KVR100	2 x KGG100
RAIMAX 150	KSR M20X	KCC150	4 x KVCC150	KVR150	2 x KGG150

Code N.

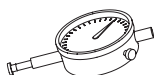
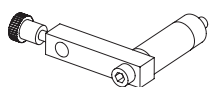

MISURAIMAX 30-40 + Dial indicator 1/100 0-5 mm
 MISURAIMAX 30-40 + Dial indicator 1/100 0-5 mm
 MISURAIMAX 50 + Dial indicator 1/100 0-10 mm
 MISURAIMAX 75 + Dial indicator 1/100 0-10 mm
 MISURAIMAX 100 + Dial indicator 1/100 0-10 mm
 MISURAIMAX 150 + Dial indicator 1/100 0-10 mm



RAIMAX® TESTINA REGOLABILE PER ALESATURA Ø28-250

MISURAIMAX® DISPOSITIVO MISURATORE

Montabili sui mandrini porta-frese comunemente reperibili in commercio

Testina RAIMAX

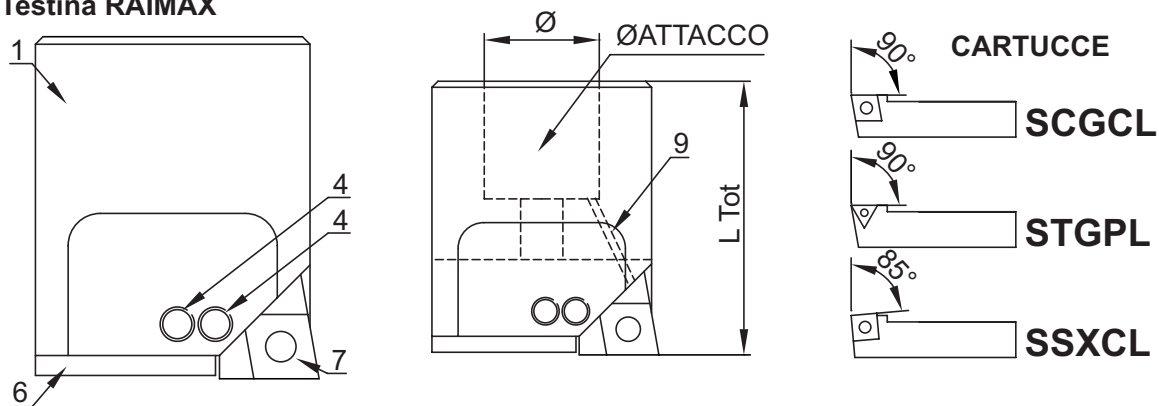

SENZA COPERCHIO

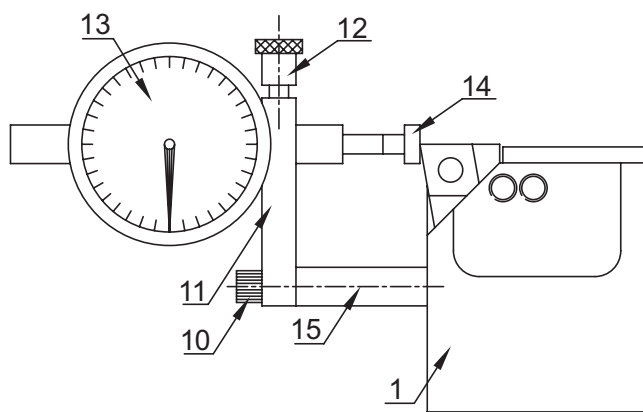
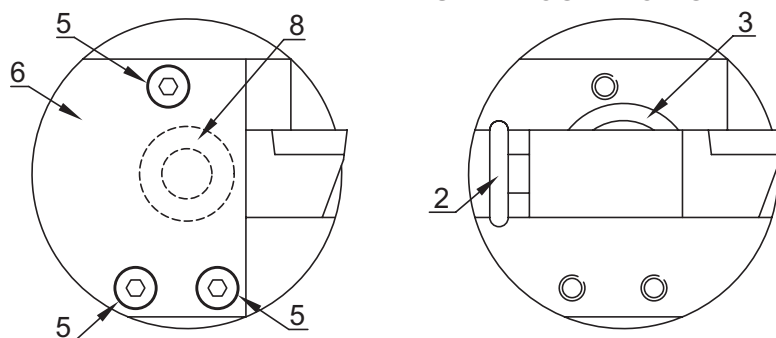

- 1_ Corpo bareno RAIMAX
- 2_ Vite di regolazione cartuccia
- 3_ Vite di bloccaggio cono
- 4_ Grano di bloccaggio cartuccia
- 5_ Viti di bloccaggio coperchio
- 6_ Coperchio
- 7_ CARTUCCIA
- 8_ Molla a tazza
- 9_ Foro di lubrificazione
- 10_ Vite di bloccaggio MISURAIMAX
- 11_ Braccetto
- 12_ Vite di bloccaggio Comparatore
- 13_ COMPARATORE
- 14_ Puntalino piatto per Comparatore
- 15_ Cilindro forato



RAIMAX® EINSTELLBARER AUSDREHKOPF

MISURAIMAX®
MESSUHR

Der einstellbare RAIMAX Ausdrehkopf ermöglicht Bohr- und Ausdrehbearbeitungen. Alle Ausdrehköpfe mit Kühlkanal. Mit Drehung einer Schraube erfolgt die Einstellung vom Schneiddurchmesser des Werkzeuges.

Die Schraube verursacht die Gleitung vom Wendeplattenhalter in der U-Nut des Kopfes.

Die RAIMAX Ausdrehköpfe werden auf gewöhnlichen Aufnahmedorne eingespannt.

Zur zentesimalen Verstellung vom Schneiddurchmesser wird das MISURAIMAX Gerät verwendet. MISURAIMAX besteht aus einem Einspannhalter, einem gebohrten Zylinder und einer Messuhr mit 1/100- und 1/1000 Ablesung.

RAIMAX GEBRAUCHSANWEISUNGEN:

1. Abschrauben Sie die drei Schrauben (5) und entnehmen Sie den Deckel
2. Lockern Sie die zwei Schrauben (4)
3. Ziehen Sie die Kassette (7) von dem Sitz heraus.
4. Stellen Sie den Kopf auf die Aufnahme und klemmen Sie die Spanschraube (3)
5. Stellen Sie die Kassette (7) wieder in die Nut.
6. Montieren Sie wieder den Deckel und stellen Sie die drei Schrauben fest (5)
7. Zur Einstellung vom Schneiddurchmesser drehen Sie die Einstellungsschraube (2). Die Kassette bewegt sich.
8. Schrauben Sie die zwei Schrauben (4)
9. RAIMAX Ausdrehkopf ist zur Verwendung bereit

MISURAIMAX GEBRAUCHSANWEISUNGEN:

1. Prüfen Sie, dass die zwei Schrauben der Kassette gespannt sind.
2. Montieren Sie MISURAIMAX, ohne Messuhr, auf dem Grundkorp der Kassette. Schrauben Sie die Schraube (10)
3. Stellen Sie die Messuhr in die Bohrung des Einspannhalters (11). Nähern Sie an den Kopf, damit die Tastspitze (14) die Plattenkanten der Kassette berührt. Spannen Sie die Klemmschraube der Messuhr.
4. Stellen Sie die Messuhr auf Null.
5. Lockern Sie die Spanschraube der Kassette (4)
6. Zur Änderung vom Ausdrehdurchmesser drehen Sie die Einstellungsschraube (2) und lesen Sie den zentesimalen Wechsel auf dem Display.
7. Spannen Sie die Schrauben (4)
8. Zur Demontage von MISURAIMAX schrauben Sie die Klemmschraube ab (10)
9. RAIMAX ist zur Verwendung bereit.



RAIMAX® ADJUSTABLE BORING HEAD

MISURAIMAX®
MEASUREMENT DEVICE

RAIMAX adjustable head allows boring operations. Boring Heads supplied with coolant hole.

The adjustment of cutting diameter of the tools is obtained rotating a screw. In this way an insert-cartridge positioned in the U-slot of the tool will slide at radial direction of the head.

This kind of boring head can be fixed on common face mill holders.

For the centesimal adjustment of cutting diameter you can use the MISURAIMAX device, composed of a holding bar, a drilled cylinder and a centesimal/thousandth dial gauge.

RAIMAX INSTRUCTIONS:

1. Unscrew the three screws (5) and remove the cover (6)
2. Loosen the two screws (4)
3. Remove the cartridge (7) from the slot
4. Fix the head on the holder and clamp it with the screw (3)
5. Put again the cartridge (7) in the slot.
6. Tighten the screws (5) to assembly the cover
7. Adjust the measure of cutting diameter rotating the screw. This will cause the shifting of the cartridge.
8. Tighten the two screws (4)
9. RAIMAX boring head is ready to be used

MISURAIMAX INSTRUCTIONS:

1. Check the two locking screws of the cartridge (4). These must be tightened.
2. Fix MISURAIMAX without dial gauge up to the head and tighten the screw (10).
3. Insert the dial gauge in the holding bar, push it up to the head till the contact point will touch the edge of insert of cartridge. Then tighten carefully the locking screw of the dial gauge (12).
4. Zerofill the dial gauge
5. Loosen the two locking screws of the gauge (4)
6. Modify the boring diameter of the head rotating the adjustment screws (2). Check also the centesimal variation on the gauge display.
7. After getting the measure, tighten the screws (4)
8. Remove MISURAIMAX loosening the screws (10)
9. RAIMAX is now ready to be used



Головки RAIMAX предназначены для расточных операций. В корпусе головки находятся отверстия для подвода СОЖ. Настройка диаметра инструмента осуществляется путем вращения установочного винта. Таким образом, картридж с режущей пластиной перемещается в U-образном пазу корпуса головки в радиальном направлении. Расточные головки устанавливаются на оправки для насадных фрез. Если вам необходима точность диаметра головки до сотых, предлагаем вам использовать приспособление для настройки MISURAIMAX, состоящее из кронштейна, цилиндра с отверстием и индикатора с ценой деления 0,01 мм/0,001 мм.

ИНСТРУКЦИЯ К ГОЛОВКЕ RAIMAX

- 1 Открутите три винта (5) и снимите крышку (6)
- 2 Ослабьте два винта (4)
- 3 Выньте картридж (7) из паза
- 4 Установите головку на оправку и закрепите винтом (3)
- 5 Закрепите картридж (7) в пазу
- 6 Закрутите винты (5), чтобы закрепить крышку
- 7 Вращение установочного винта приведет к движению картриджа. Произведите настройку диаметра инструмента.
- 8 Затяните два винта (4)
- 9 Головка RAIMAX готова к применению

ИНСТРУКЦИЯ К ПРИСПОСОБЛЕНИЮ MISURAIMAX

- 1 Убедитесь, что оба стопорных винта картриджа (4) затянуты.
- 2 Установите MISURAIMAX без индикатора на расточную головку и закрутите винт (10).
- 3 Закрепите индикатор в кронштейн, прижимайте его к инструменту до тех пор, пока ножка индикатора не упрется в режущую кромку пластины.
- 4 Обнулите индикатор
- 5 Ослабьте два стопорных винта (4) картриджа
- 6 Настройте диаметр головки, поворачивая установочный винт (2). Проверьте также шкалу сотых на циферблате индикатора.
- 7 После получения необходимого размера, затяните винты (4)
- 8 Отсоедините MISURAIMAX, ослабив винт (10)



La Tête à aléser RAIMAX permet des exécutions d'alésage et perçage. Les têtes ont le trou d'arrosage. Le diamètre de coupe de l'outil est réglé par la rotation d'une vis. Cette rotation cause le glissement d'une porte-plaquettes situé dans une U-rainure obtenue dans le corps de l'outil. L'attachement de la tête permet le montage sur des communes mandrins porte-fraises. Pour obtenir la régulation centésimale du diamètre de coupe on utilise le dispositif MISURAIMAX, composé d'un support, un cylindre percé et un comparateur 1/100 – 1/1000.

MODE D'EMPLOI DE RAIMAX :

1. Dévisser les trois vis (5) et enlever le couvercle.
2. Desserrer les deux vis (4)
3. Extraire le porte-plaquette (7) de son emplacement.
4. Monter la tête sur le mandrin et fixer avec la vis (3)
5. Poser le porte-plaquette (7) dans l'emplacement.
6. Monter le couvercle et visser le trois vis (5)
7. Régler la dimension du diamètre de coupe et tourner la vis (2). Le porte-plaquettes (7) va glisser.
8. Serrer les deux vis (4)
9. La tête RAIMAX est prête pour être utilisée.

MODE D'EMPLOI DE MISURAIMAX:

1. Les vis de serrage du porte-plaquettes (4) doivent être bien fermées.
2. Monter le MISURAIMAX sans comparateur sur le corps de la tête et visser la vis (10)
3. Introduire le comparateur dans le trou du support (11) et le rapprocher à la tête d'alésage. La touche (14) doit toucher le coin de la plaquette. Fermer doucement la vis de serrage du comparateur (12).
4. Mettre le comparateur à zéro.
5. Dévisser les deux vis de serrage du porte-plaquettes (4)
6. Pour modifier le diamètre d'alésage de la tête il faut tourner la vis de réglage (2) et contrôler la variation centésimale sur le cadran du comparateur.
7. Quand on a obtenu la dimension désirée, fermer les vis (4)
8. Desserrer les vis pour démonter MISURAIMAX (10)
9. RAIMAX est prête pour être utilisée



RAIMAX® TESTINA REGOLABILE PER ALESATURA

MISURAIMAX®
DISPOSITIVO MISURATORE

La testina regolabile RAIMAX permette l'esecuzione di lavorazioni di barenatura e alesatura. Tutte le testine hanno il foro di lubrificazione. La regolazione del diametro di taglio dell'utensile e' ottenuta tramite la rotazione di una vite. Quest'ultima fa scorrere, radialmente all'asse di rotazione della testina, una cartuccia ad inserti posizionata all'interno di una scanalatura a forma U ricavata nel corpo dell'utensile in commercio. Per la regolazione centesimale del diametro di taglio si utilizza il dispositivo MISURAIMAX composto da un braccetto, un cilindretto forato ed un comparatore centesimale o millesimale.

ISTRUZIONI D'USO PER IL RAIMAX:

- 1 Svitare le tre viti (5) e togliere il coperchio (6)
- 2 Allentare le due viti (4)
- 3 Estrarre la cartuccia (7) dal suo alloggiamento
- 3 Montare la testina sul mandrino e bloccarla tramite la vite (3)
- 5 Ricollocare la cartuccia (7) nel suo alloggiamento
- 6 Rimontare il coperchio riavvitando le tre viti (5)
- 7 Regolare la misura del diametro di taglio facendo ruotare la vite (2) la quale permette lo spostamento della cartuccia (7)
- 8 Riavvitare le due viti (4)
- 9 La testina RAIMAX e' pronta per essere utilizzata

ISTRUZIONI D'USO PER IL MISURAIMAX:

- 1 Assicurarci che le due viti di bloccaggio della cartuccia (4) siano serrate
- 2 Montare il MISURAIMAX senza comparatore al corpo della testina avvitando la vite (10)
- 3 Introdurre il comparatore all'interno del foro del braccetto (11), avvicinarlo alla testina fino a far toccare il puntalino (14) sullo spigolo dell'inserto della cartuccia e serrare in maniera non eccessiva la vite di bloccaggio del comparatore (12)
- 4 Azzerare il comparatore
- 5 Allentare le due viti di bloccaggio della cartuccia (4)
- 6 Modificare il diametro di alesatura della testina facendo ruotare la vite di regolazione (2) e leggendo la variazione centesimale sul quadrante del comparatore
- 7 Ottenuta la misura desiderata bloccare le viti (4)
- 8 Smontare il MISURAIMAX svitando la vite (10)
- 9 La testina RAIMAX e' pronta per essere utilizzata



RAIMAX® 可调镗头

MISURAIMAX®

RAIMAX 可调镗头允许钻孔操作，镗头配有冷却孔。
工具切削直径由旋转螺钉来调整。这种方式下，工具U型槽的内置刀头就会向镗头径向方向滑动。
这种镗头可以固定在普通端面铣刀柄上。
可以使用MISURAIMAX 装置来进行切削直径的细微调整，
这种装置由一个夹持杆，一个钻孔的圆柱体和一个百分表或者千分表组成。

RAIMAX 用法说明

1. 拧开三处螺丝 (5)，取下盖子 (6)。
2. 松开两处螺丝 (4)
3. 从槽内取出刀头 (7)
4. 固定在刀柄上，用螺丝 (3) 拧紧
5. 再把刀头 (7) 放在槽内
6. 拧紧螺丝 (5)，合上盖子
7. 调整切削直径并旋转螺丝。这会使得刀头移位。
8. 拧紧两处螺丝 (4)
9. RAIMAX 镗头可以开始使用了。

MISURAIMAX 使用说明

1. 检查刀头 (4) 两处的紧固螺丝。确保它们已经拧紧。
2. 固定 MISURAIMAX，使百分表不能碰到镗头，并拧紧螺丝 (10)。
3. 在刀杆处放入百分表，推向刀头直至百分表测头刚好碰到刀头上刀片的边缘。
4. 百分表归零
5. 松开百分表的两个紧固螺丝 (4)
6. 修改镗头直径，旋转可调螺丝 (2)
同时检查百分表显示的读数变化
7. 得到测量值之后，拧紧螺丝 (4)
8. 松开螺丝 (10)，移开 MISURAIMAX
9. RAIMAX 现在可以开始使用了